

Article number: 390213001553510

Description: Worm gear
VF 130-FC2-15-90B5, without lubrication

Measures

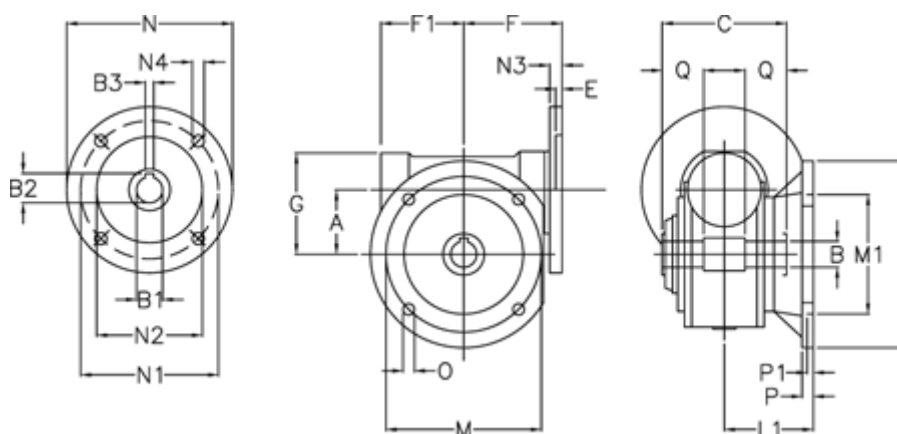

A	= 130	F1	= 154	N2	= 130
B	= 45 H7	G	= 195	N3	= 17
B1	E7 = 24	L	= 320	N4	= 11
B2	= 27.3	L1	= 137.5	O	= 16
B3	H9 = 8	M	= 255	P	= 20
C	= 165	M1	= 180	P1	= 12
E	= 0.5	N	= 200	Q	= 52.5
F	= 185	N1	= 165		